

No. 12010511J

AUDI

JAEGER

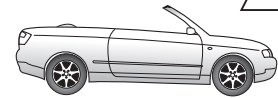
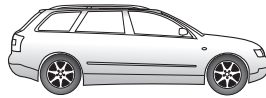
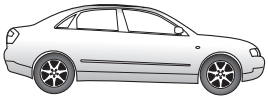

A4 Limousine 11/04 → 10/07
A4 Saloon 11/04 → 10/07

A4 Avant 11/04 → 03/08 **A4 Cabriolet** 02/06 →

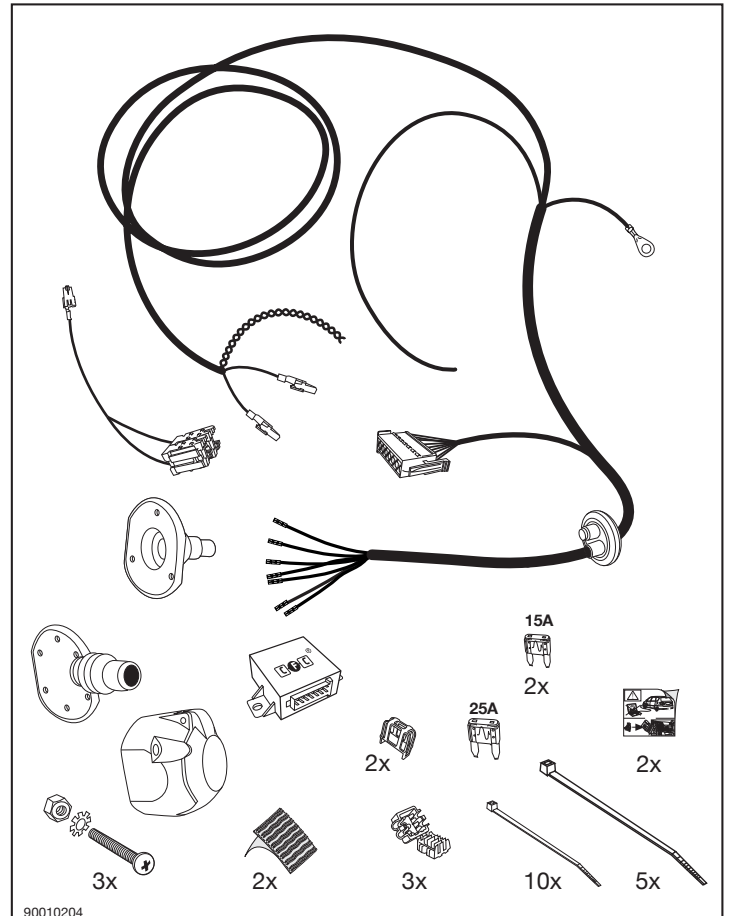
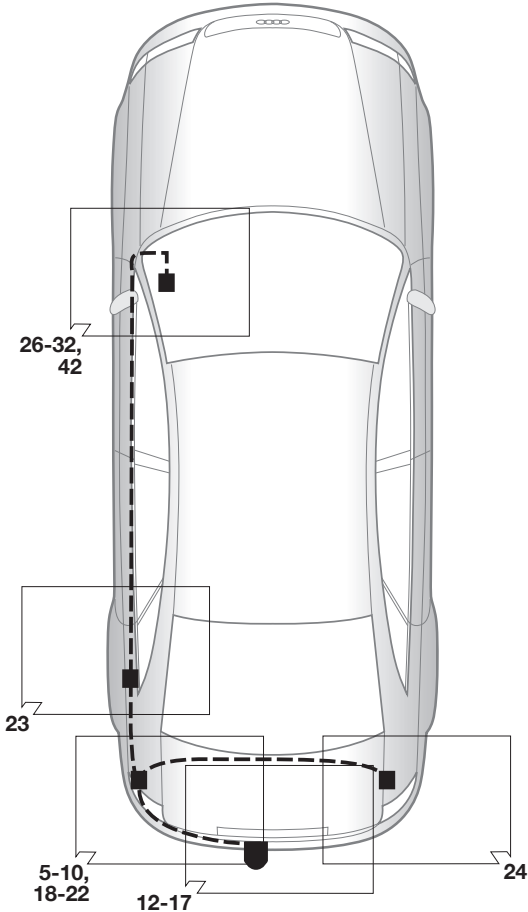

! Der Einbau dieses Elektrosatzes muß von einer Fachwerkstatt oder einer entsprechend qualifizierten Person durchgeführt werden. Vor Beginn aller Montagearbeiten unbedingt die Einbauanleitung komplett durchlesen. Nach Einbau des Elektrosatzes ist die Einbauanleitung den Serviceunterlagen des Fahrzeuges beizulegen!

Bei unsachgemäßer Anwendung oder Veränderung des Elektrosatzes bzw. der darin befindlichen Bauteile erlischt jeder Anspruch auf Gewährleistung. Beim Fahren ohne Anhänger oder Ladungsträger müssen ggf. verwendete Adapter immer aus der Steckdose entfernt werden. Änderungen bezüglich Konstruktion, Ausstattung, Farbe sowie Irrtum vorbehalten. Alle Angaben und Abbildungen unverbindlich.

Bei Anhängern ohne Nebelschlussleuchte sollte diese nachgerüstet werden.

Für technische bzw. elektronische Änderungen, welche nach erstmaliger Inbetriebnahme des Elektrosatzes vom Fahrzeughersteller durchgeführt werden und beispielsweise zu Fehlfunktionen der Anhängersteckdose oder deren Peripherie führen, übernehmen wir keinerlei Gewährleistung!

Das Anhängermodul ist nicht diagnosefähig! Sollten herstellereitige Diagnoseprozesse bzw. softwaregestützte Prüfmechanismen Fehlerprotokolle generieren, welche direkt oder indirekt mit Anhängerbetrieb in Zusammenhang stehen, ist das Anhängermodul vom Leitungssatz für die Anhängersteckdose zu trennen und ein nochmaliger Diagnosevorgang zu starten!

! Installation of the towing electric kit must be undertaken by a specialist workshop or an appropriately qualified person. Before starting work, you must read the installation instructions through completely. After installing the towing electric kit, the installation instructions should be kept with the vehicle service documentation.

All claims under the guarantee will lapse in case of improper use or modification of the towing electric kit or any of its component parts. When driving without a trailer or load carrier, any adapter installed must be removed from the electrical socket. We reserve the right to alter the design, content or colour. We accept no liability for any errors in these instructions. All details and illustrations are non-binding.

In case of missing a rear fog lamp on the trailer, it should be retrofitted.

We accept no responsibility and give no guarantee for technical and electrical modifications made after the initial operation of the towing electric kit by the vehicle manufacturer and which may lead, for example to malfunction of the trailer socket or its peripheries.

The trailer module is not diagnostics-capable. If the manufacturer's diagnostics processes or software-supported test mechanisms generate error reports directly or indirectly linked with trailer operation, the trailer module must be disconnected from the leads to the trailer socket and a new diagnostic process initiated.

! Le montage du kit de connexion électrique doit être effectué par un atelier spécialisé ou par une personne qualifiée en la matière. Avant le début des travaux, lire impérativement les instructions de montage dans leur intégralité. Après le montage du kit de connexion électrique, joindre les instructions de montage aux documents du véhicule.

Un usage inapproprié ou des modifications du kit de connexion électrique, ou des pièces qui le composent, entraînent l'expiration de tout droit à la garantie. Lors d'une conduite sans remorque ou porteur de charge, les adaptateurs utilisés doivent, le cas échéant, toujours être enlevés de la prise de courant. Sous réserve de modifications de constructions, équipement, couleurs ou erreur. Données et illustrations sous toute réserve.

Pour les remorques qui ne sont pas équipés avec feux anti-brouillard arrière, il devrait être installé.

Nous n'assumons aucune responsabilité ni garantie pour les modifications techniques et électroniques ayant été effectuées après la première mise en service du kit de connexion électrique par le constructeur automobile et ayant mené par exemple à des mauvais fonctionnements de la prise de remorque ou de sa périphérie.

Le module remorque ne contient pas de fonction diagnostic! Au cas où des processus de diagnostic définis par le fabricant ou des mécanismes de contrôle assistés par ordinateur devaient générer des messages d'erreur directement ou indirectement en rapport avec le fonctionnement de la remorque, il est impératif pour la prise de remorque de détacher le module remorque du groupe électrique et d'initier une nouvelle procédure de diagnostic.

! L'installazione del kit elettrico deve essere effettuata da un'officina o da personale specializzato. Prima di iniziare tutti i lavori di montaggio, leggere da cima a fondo le istruzioni. Dopo aver installato il kit elettrico si prega di allegare le istruzioni di montaggio ai documenti di manutenzione del veicolo!

In caso di uso improprio o di modifiche del kit elettrico e delle componenti del medesimo, ogni diritto di garanzia decade. Durante la guida senza rimorchio o portacarichi, togliere sempre gli adattatori dalla presa di corrente. Con riserva di modifiche relative a costruzione, equipaggiamento, colore e salvo errori. Tutte le indicazioni e illustrazioni non sono vincolanti.

In caso di rimorchi non corredati di luce retronebbia, questa dovrebbe essere installata.

Per le modiche tecniche ed elettroniche eseguite dopo la prima messa in funzione del kit elettrico da parte del costruttore del veicolo, e che portano, per esempio, a un malfunzionamento della presa del rimorchio o della sua periferia, non assumiamo alcuna responsabilità.!

Il modulo del rimorchio non è idoneo alla diagnosi! Nel caso in cui processi diagnostici o apparecchiature di prova controllate da software dovessero generare dei protocolli d'errore in rapporto diretto o indiretto con l'uso del rimorchio, si deve staccare il modulo del rimorchio dal conduttore per la presa del rimorchio, e avviare nuovamente la diagnosi!

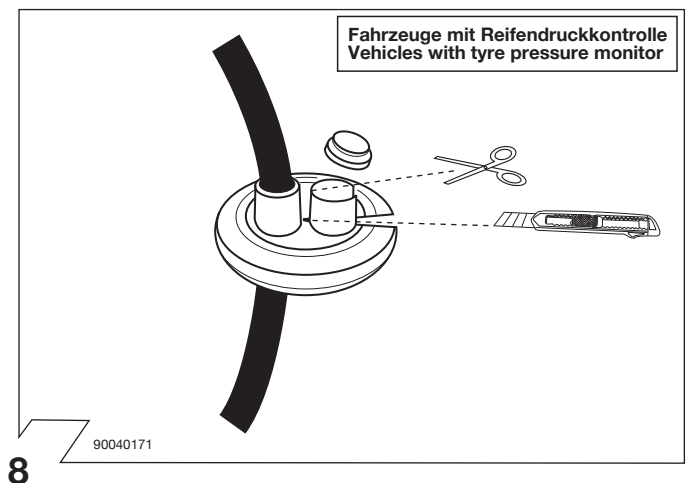
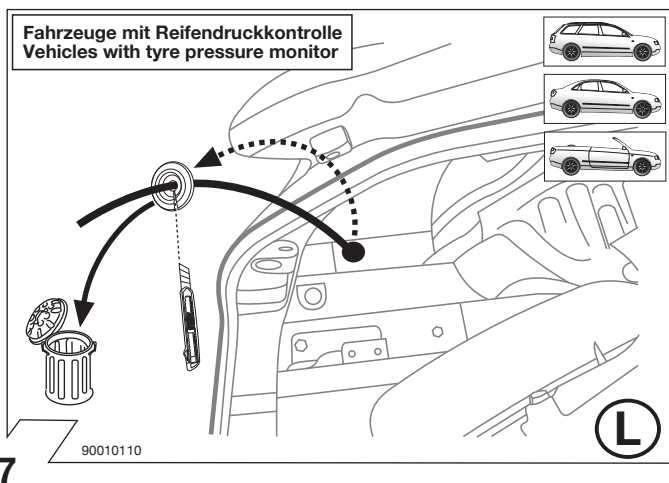
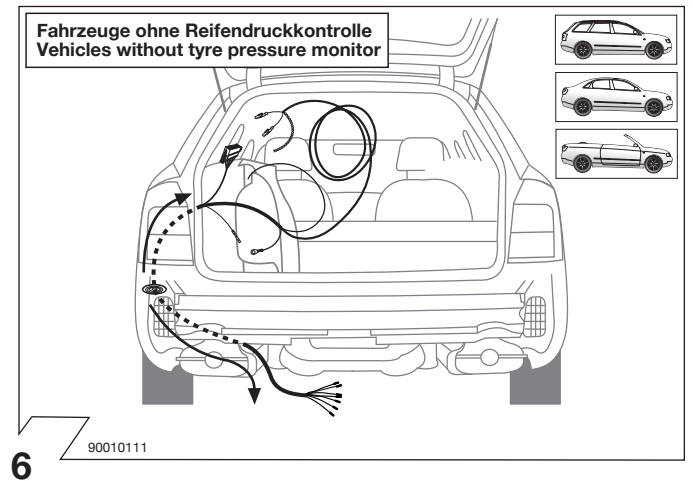
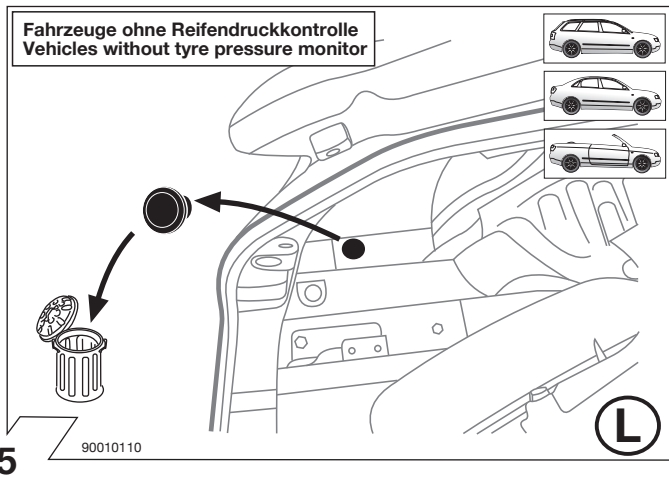
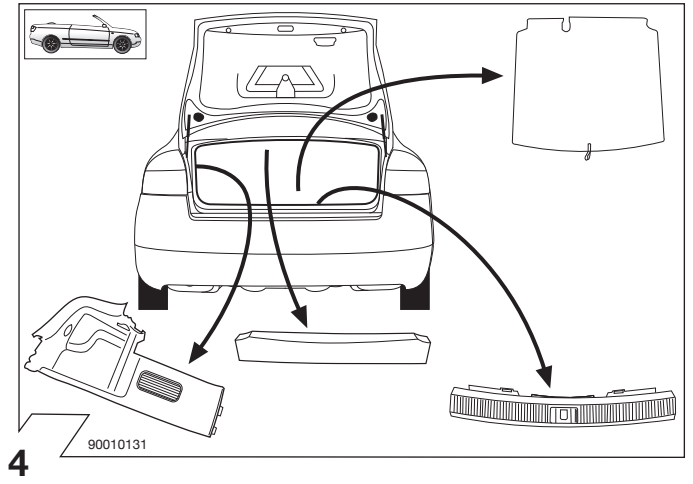
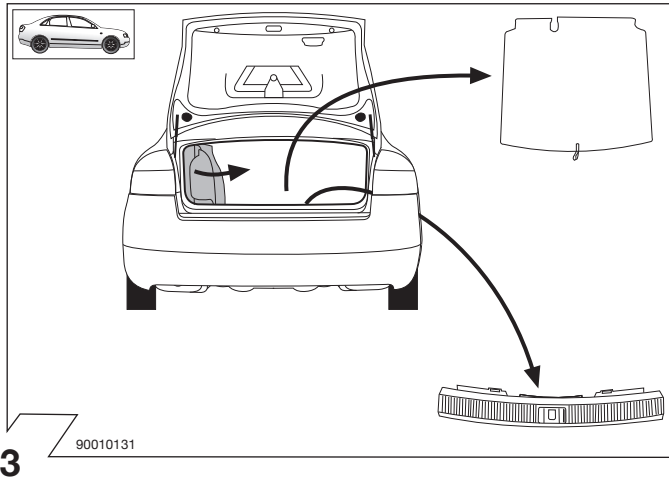
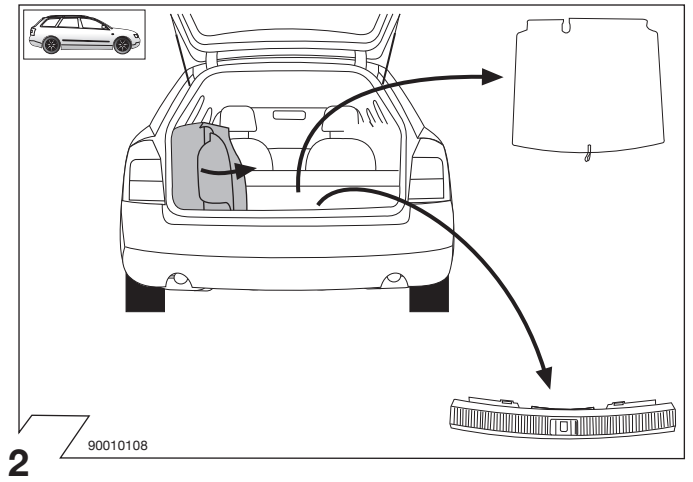
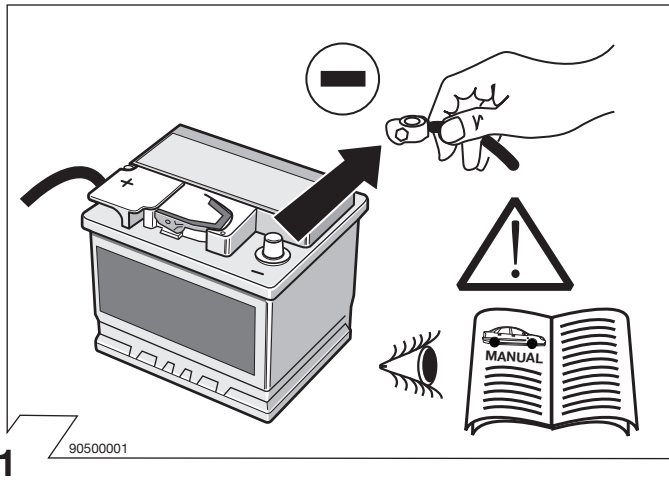

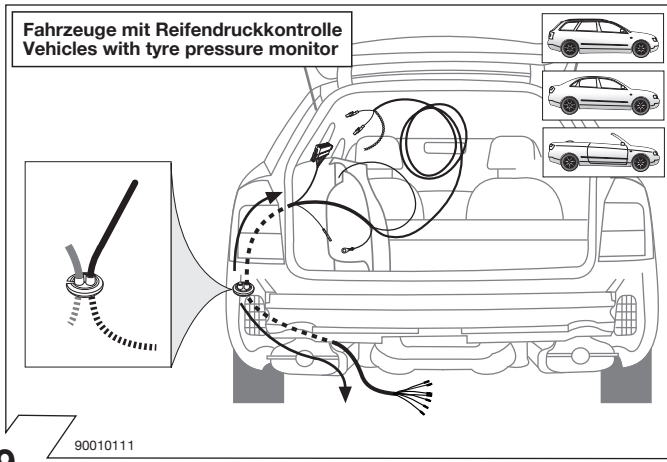

9

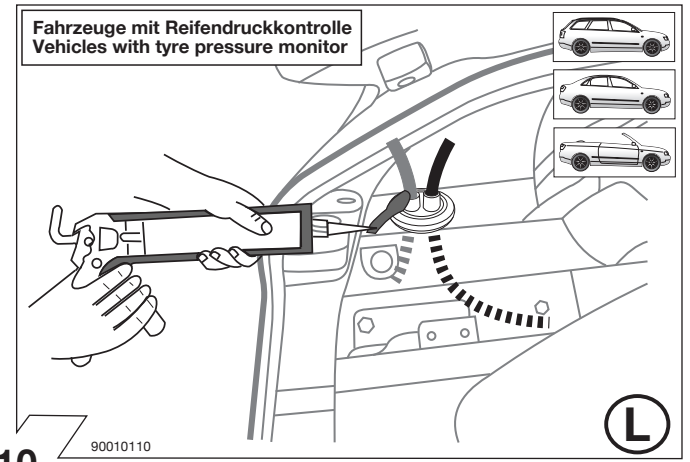

10

	GB	D	E	F	I	P	NL	DK	N	S	FIN	CZ	H	PL
BK	Black	Schwarz	Negro	Noir	Nero	Preto	Zwart	Sort	Svart	Svart	Musta	Černá	Fekete	Czarny
RD	Red	Rot	Rojo	Rouge	Rosso	Vermelho	Rood	Rød	Rød	Röd	Punainen	Červená	Piros	Czerwony
GN	Green	Grün	Verde	Vert	Verde	Verde	Groen	Gron	Grønt	Grön	Vihreä	Zelená	Zöld	Zielony
OR	Orange	Orange	Naranja	Orange	Arancione	Laranja	Oranje	Orange	Orange	Orange	Oranssi	Oran•ová	Narancs	Pomarańczowy
VT	Violet	Violett	Violeta	Violet	Viola	Violeta	Violet	Violet	Fiolett	Violett	Violetti	Fialová	Ibolya	Fioletowy
PK	Pink	Pink	Pink	Rose	Rosa	Cor-de-Rosa	Paars	Pink	Pink	Rosa	Pinkki	Růžová	Rózsaszín	Różowy
BL	Blue	Blau	Azul	Bleu	Blu	Azul	Blauw	Blå	Blått	Blå	Sininen	Modrá	Kék	Niebieski
YL	Yellow	Gelb	Amarillo	Jaune	Giallo	Amarelo	Geel	Gul	Gult	Gul	Keltainen	•lutá	Sárga	Żółty
WT	White	Weiss	Blanco	Blanc	Bianco	Branco	Wit	Hvid	Hvitt	Vit	Valkoinen	Bílá	Fehér	Biały
BR	Brown	Braun	Marrón	Brun	Marrone	Marrom	Bruin	Brun	Brunt	Brun	Ruskea	Hnědá	Barna	Brazowy
GY	Grey	Grau	Gris	Gris	Grigio	Cinzeno	Grijs	Grå	Grått	Grå	Harmaa	•edá	Szürke	Szary

90500580

11

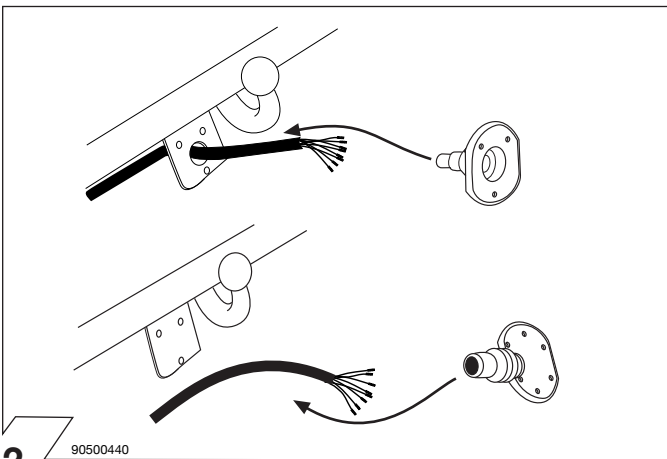

12

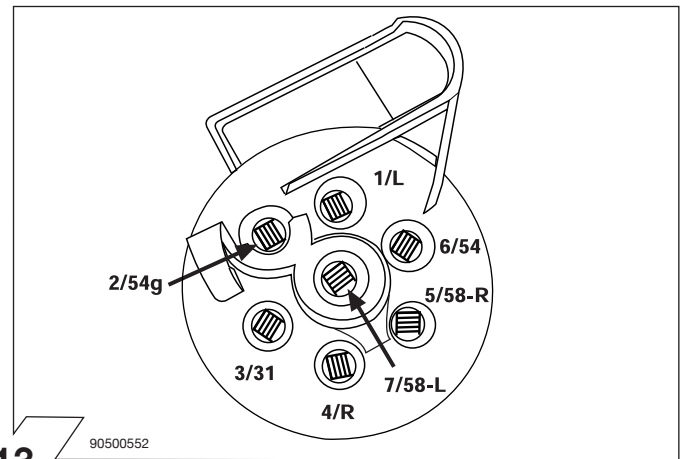

13

ISO 1724	Belegung der Steckdose/Socket Configuration Correspondance des Contacts de la prise Cavi della presa elettrica sono abbinati		
	1/L	BK/WT	21W
	2	WT	42W
	3/31	BR	
	4/R	BK/GN	21W
	5/58-R	GY/RD	52W
	6/54	BK/RD	63W
	7/58-L	GY/BK	52W

90020167

14

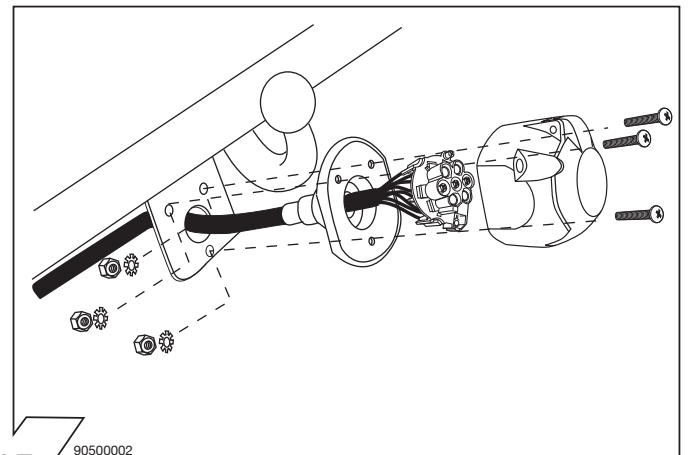

15

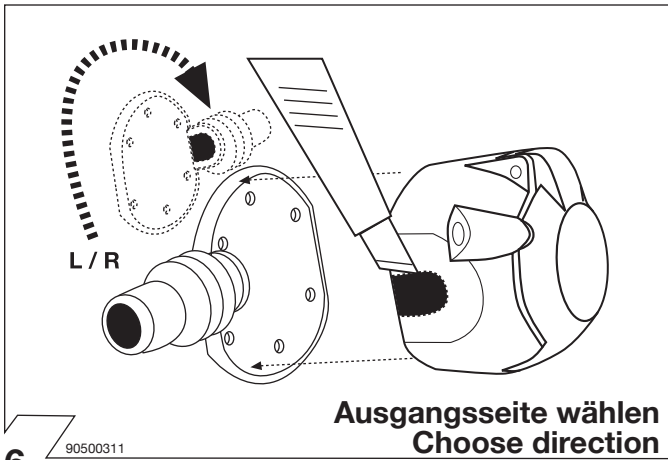

16

90500311

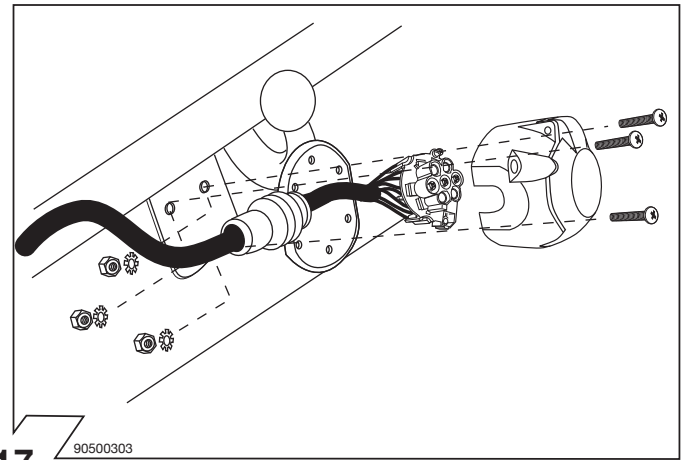

17

90500303

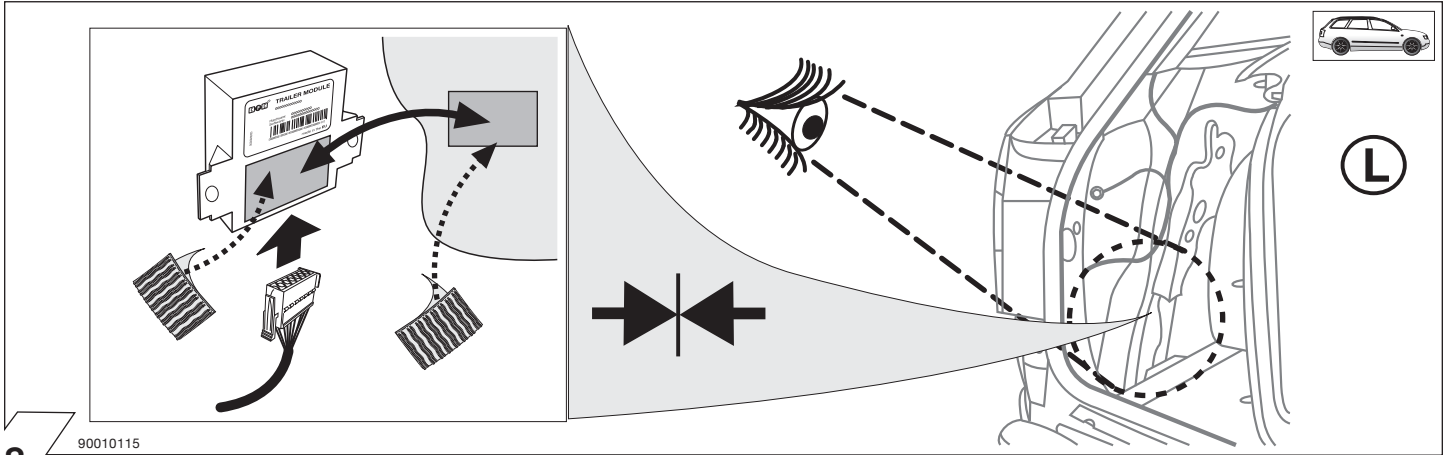

18

90010115

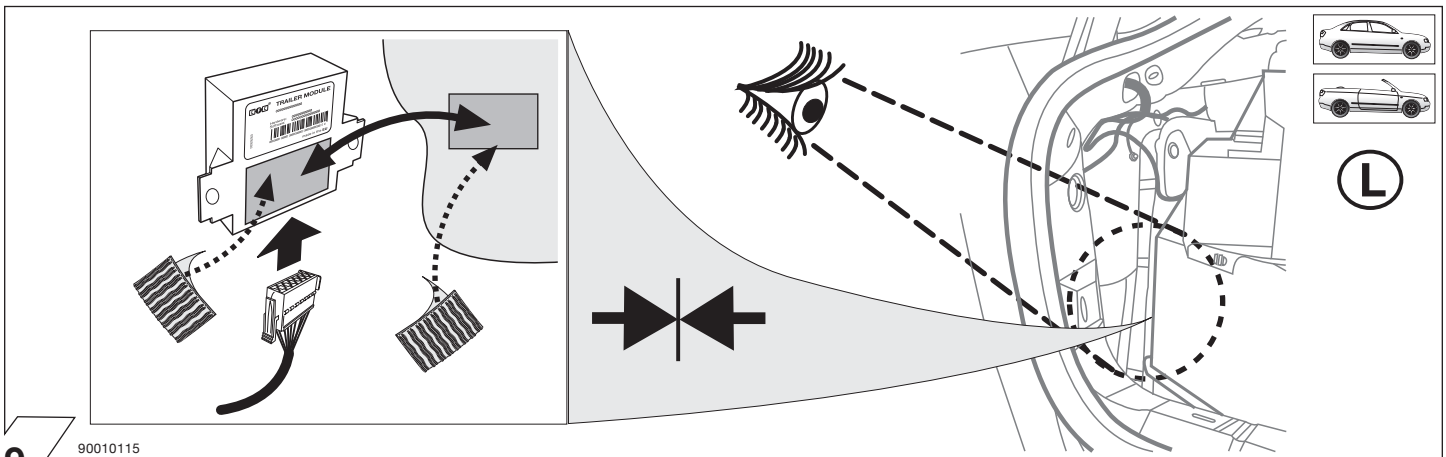

19

90010115

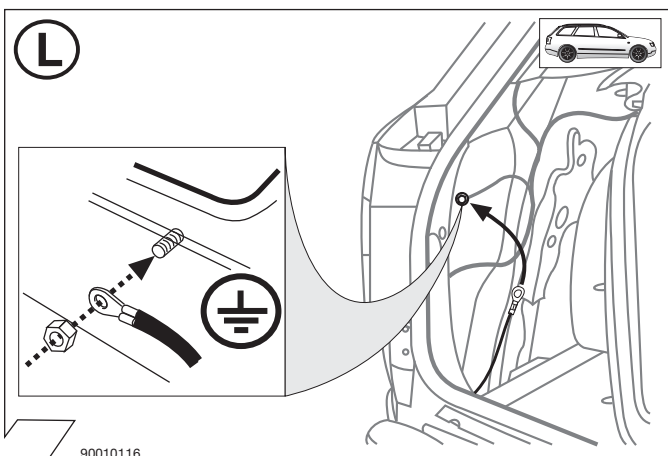

20

90010116

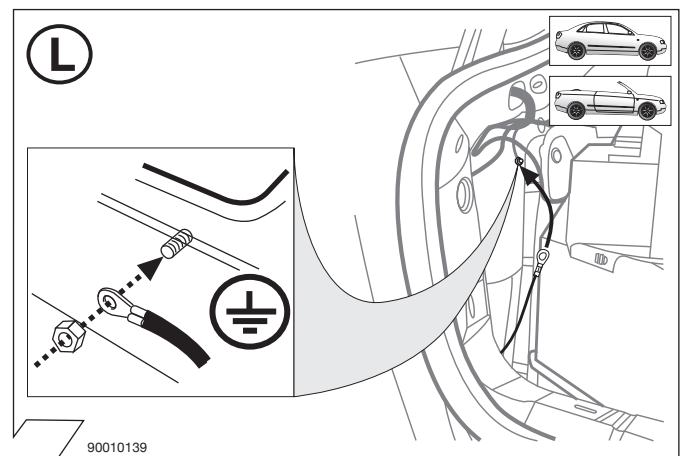

21

90010139



L

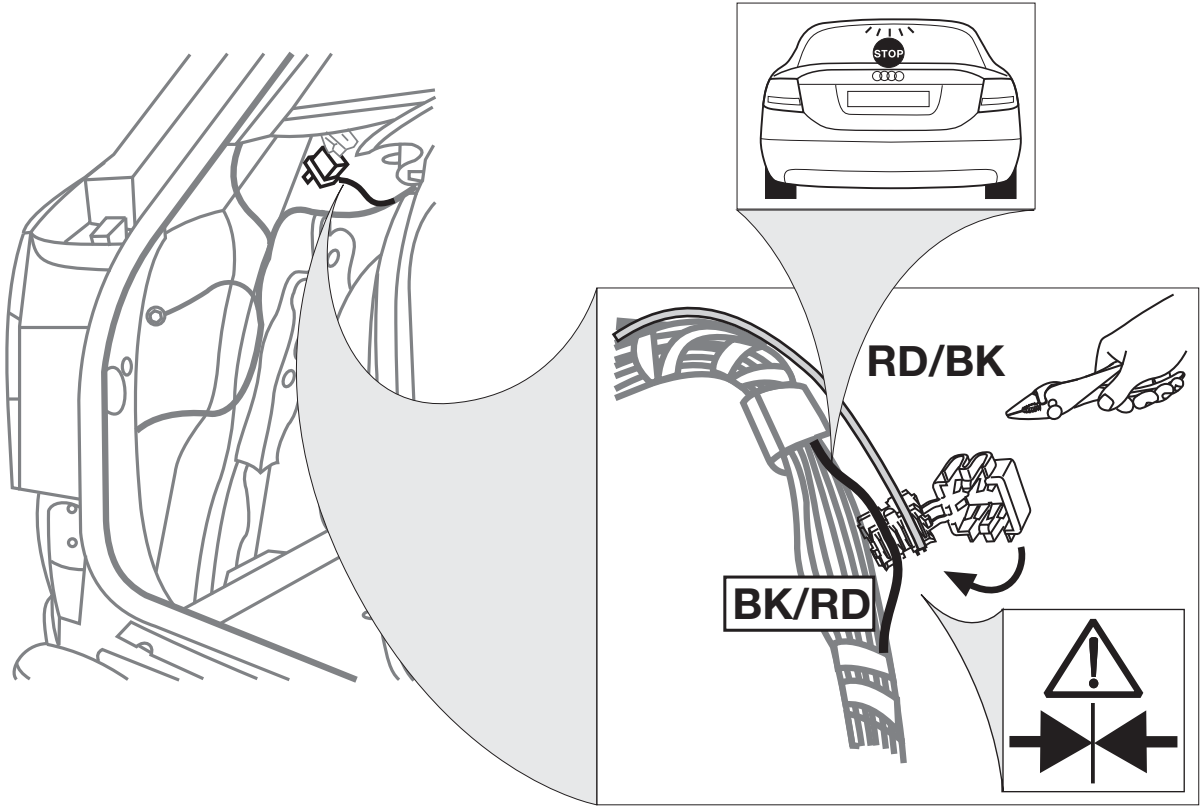

90010205

22



L

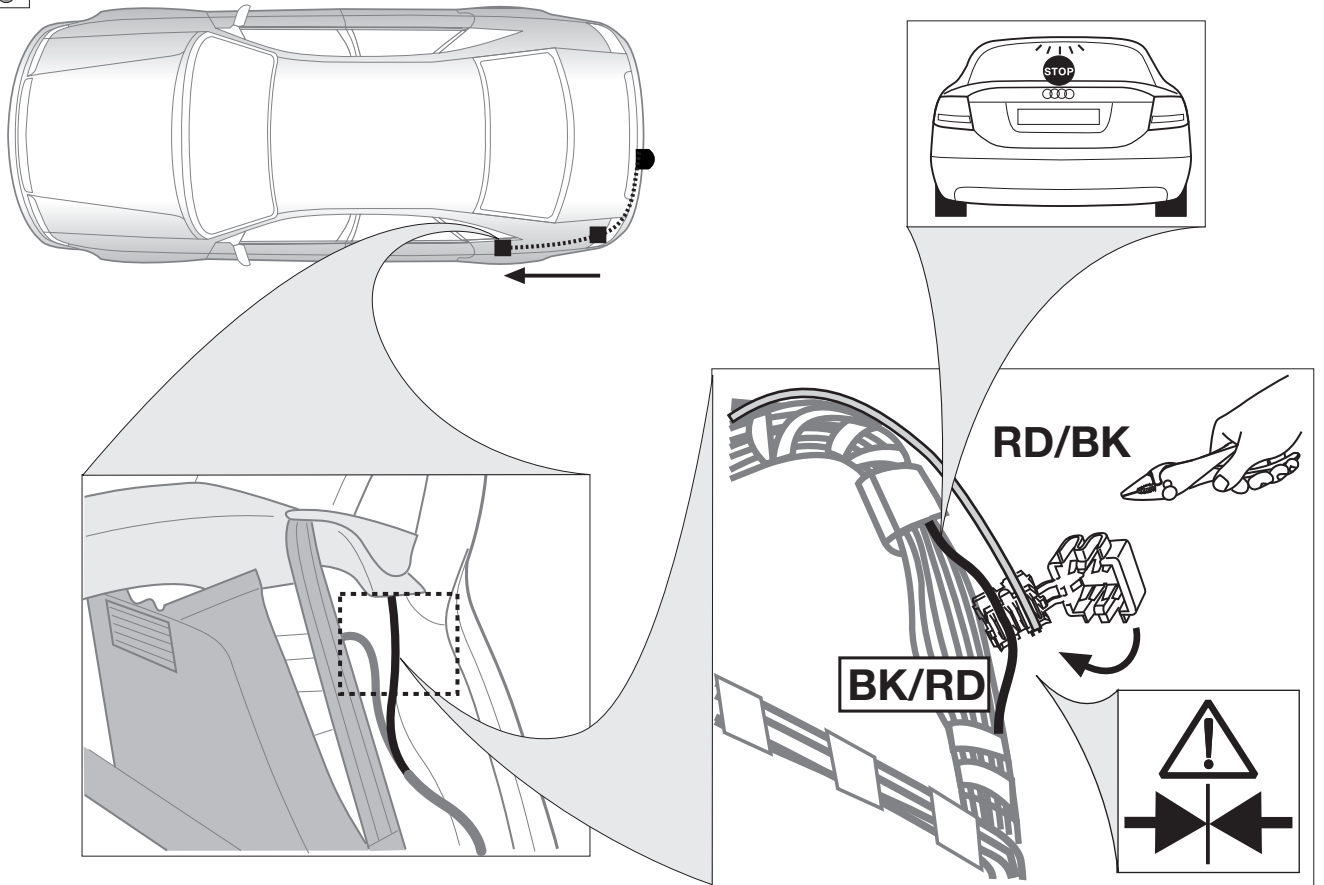

90270311

23

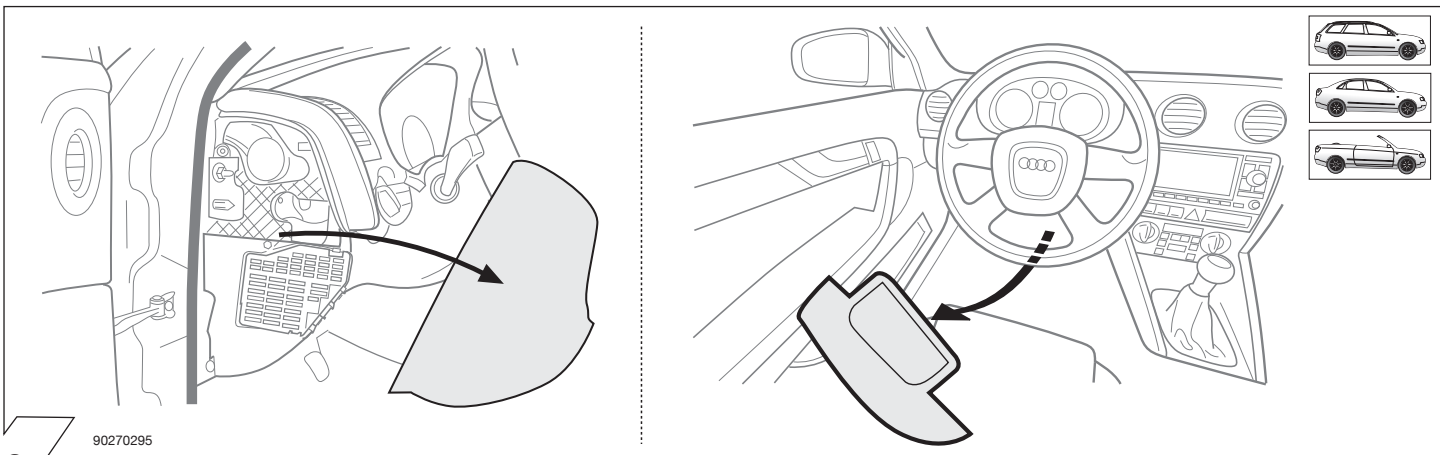
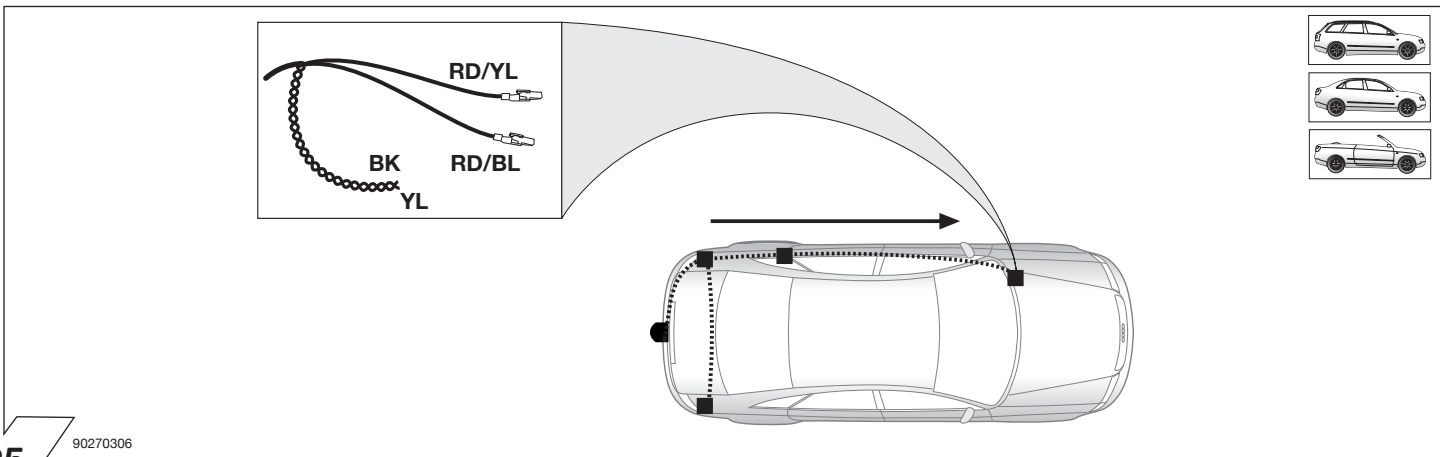
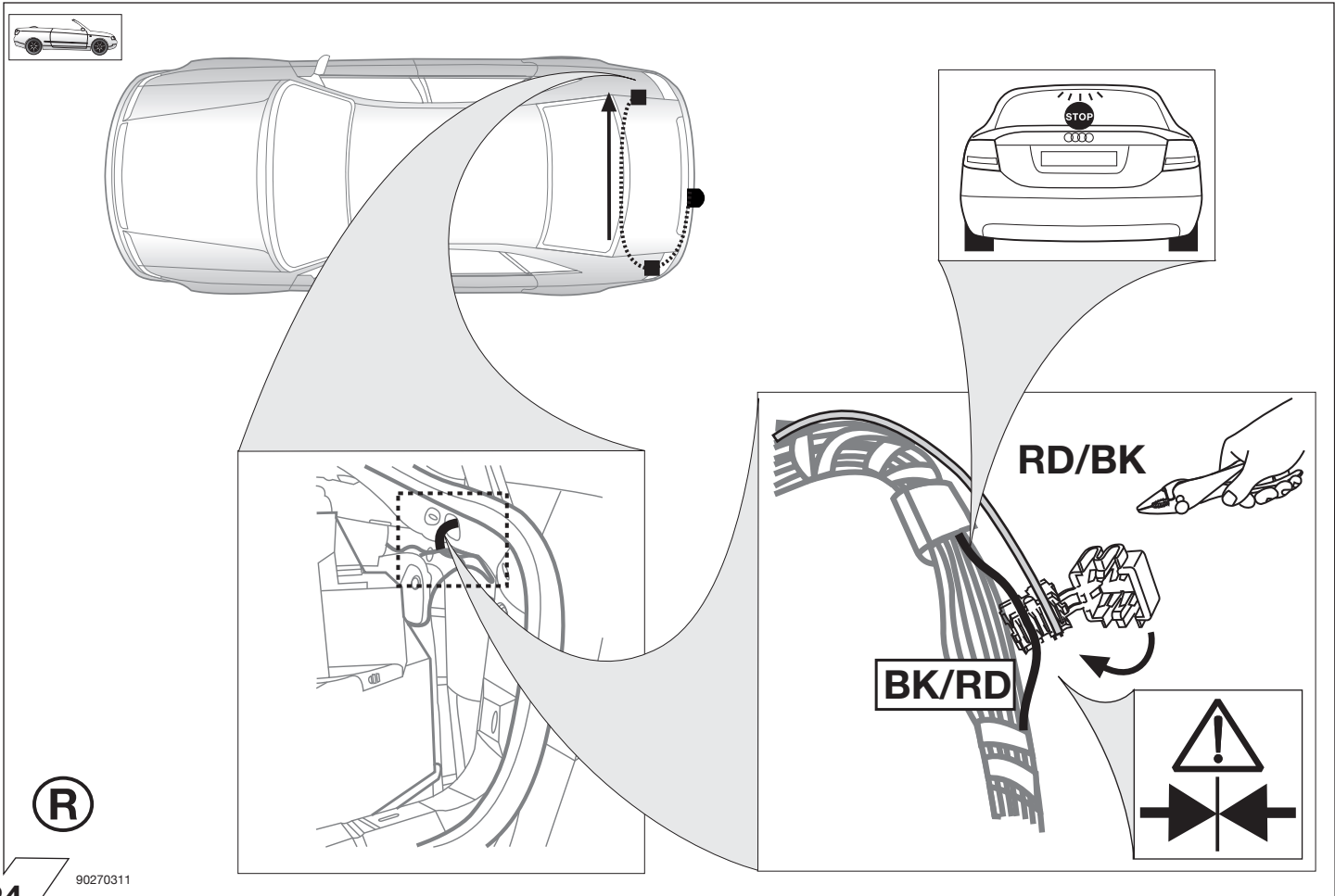

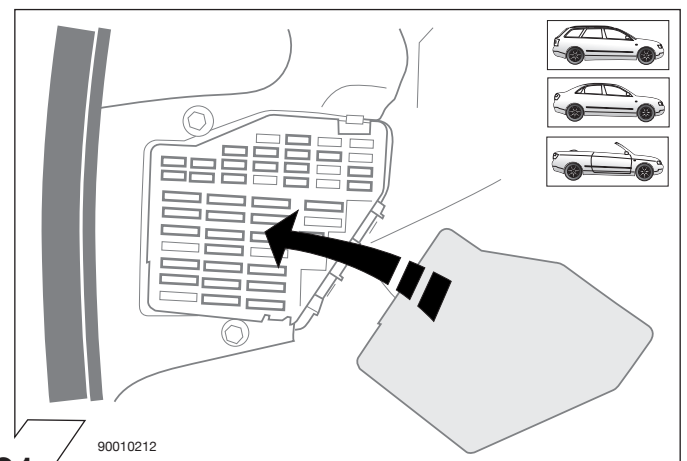
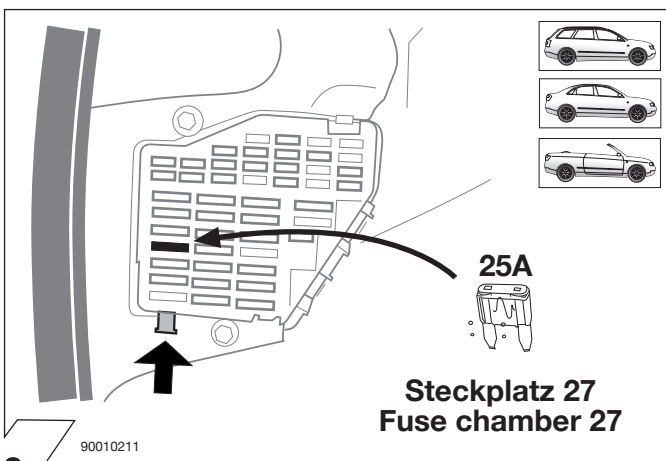
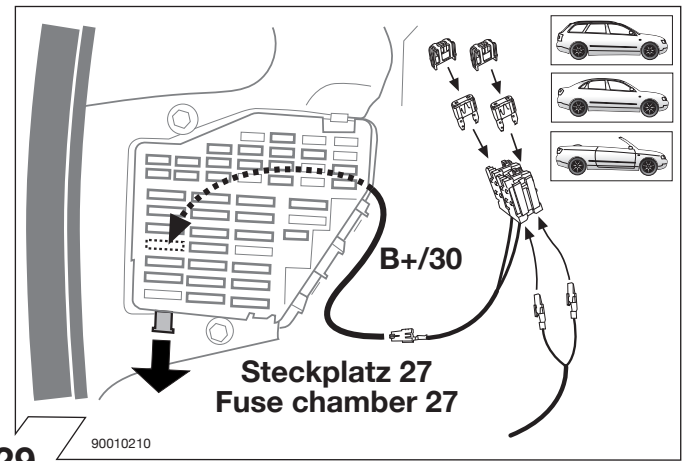
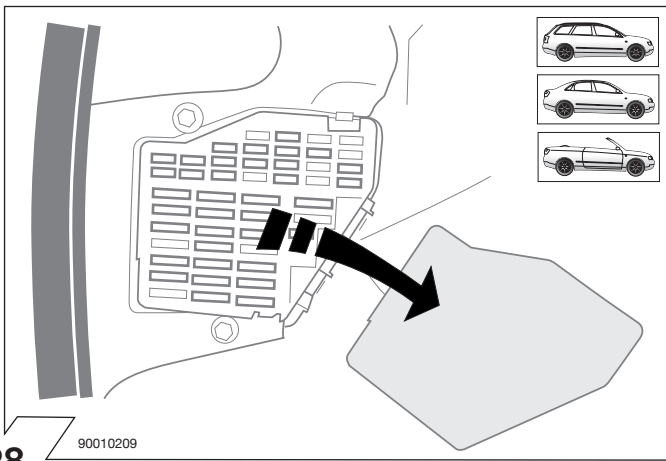
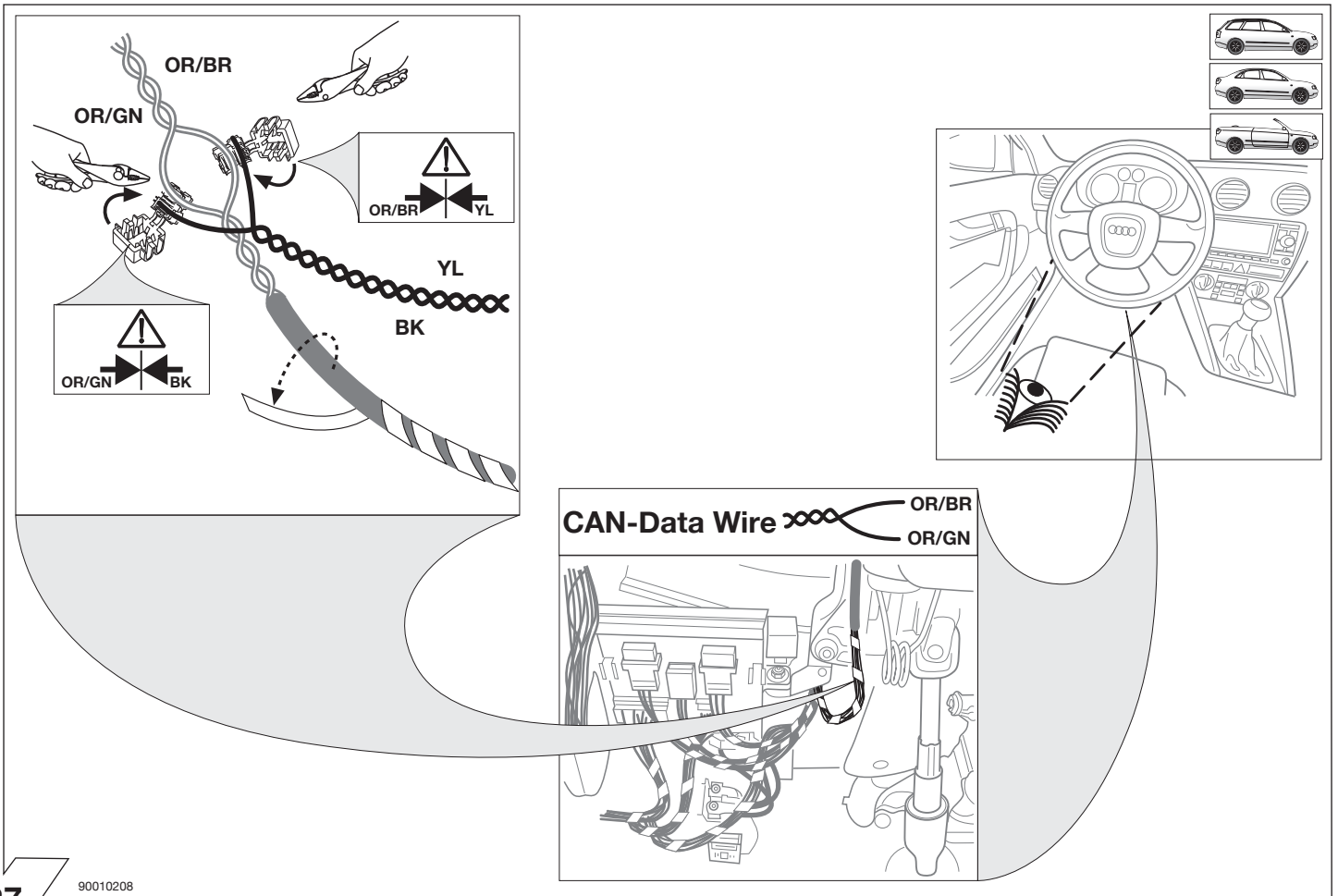

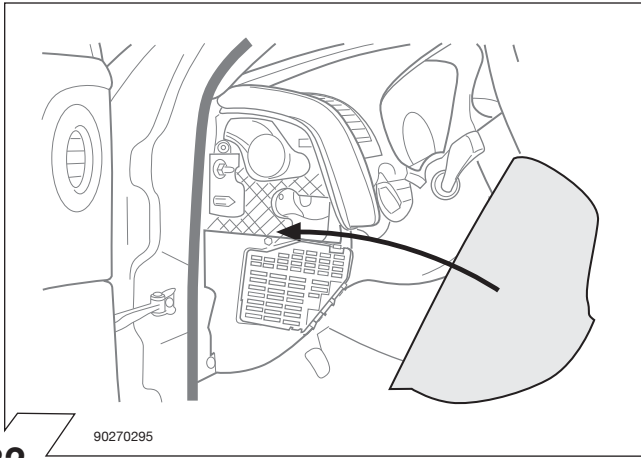

90270295

32

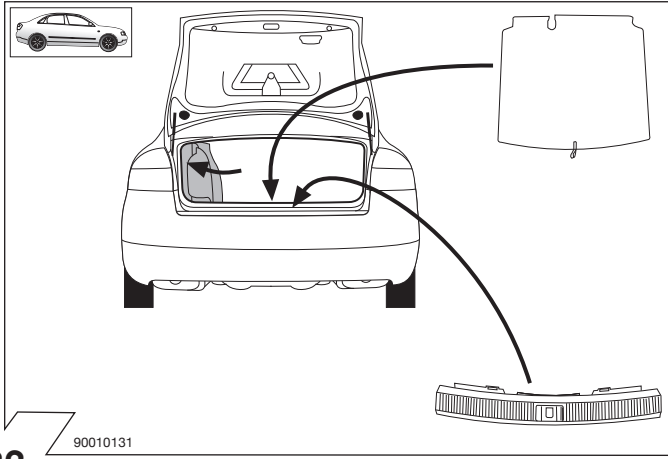
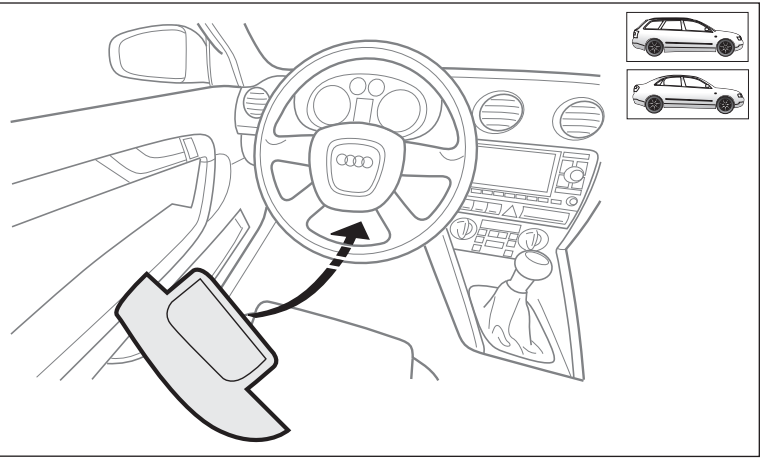

90010131

33

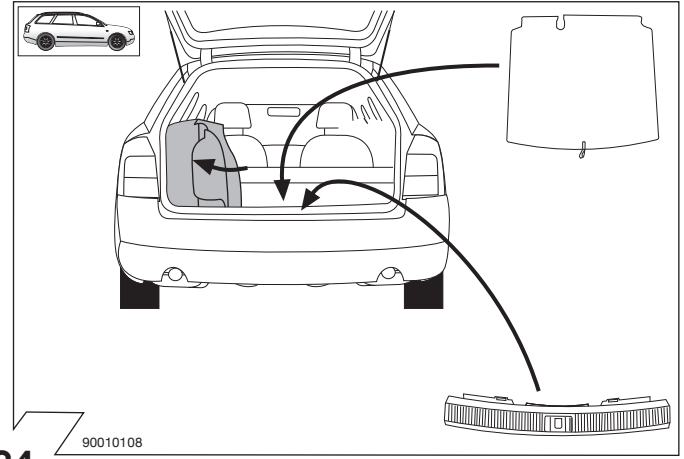

90010108

34

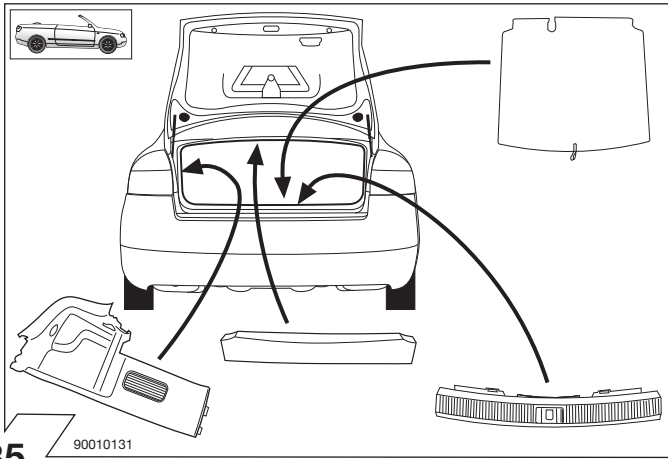

90010131

35

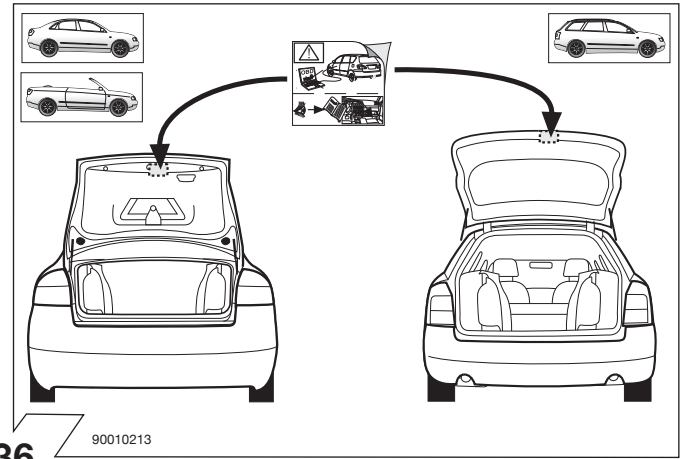

90010213

36

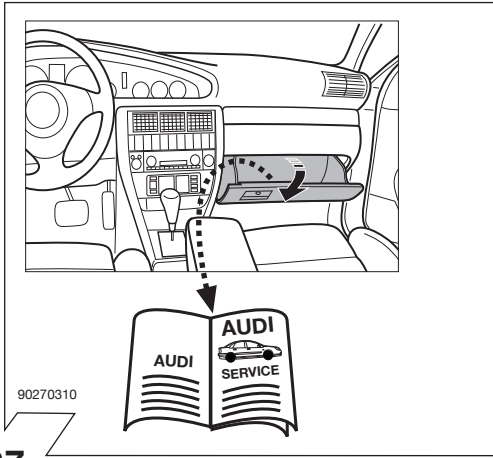

90270310

37

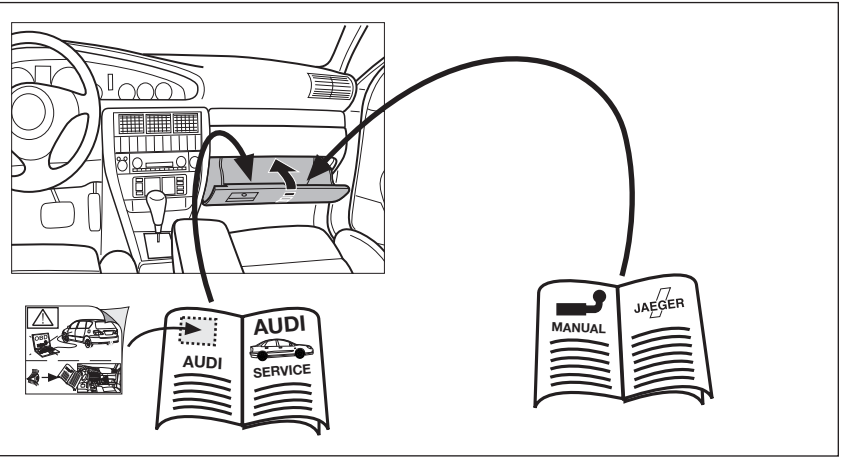

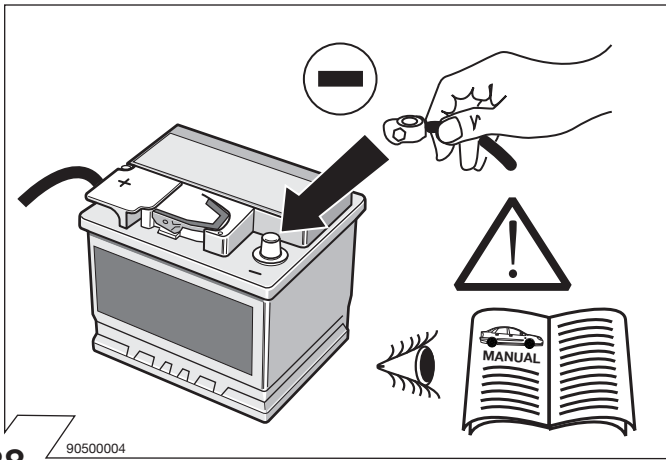

38

90500004

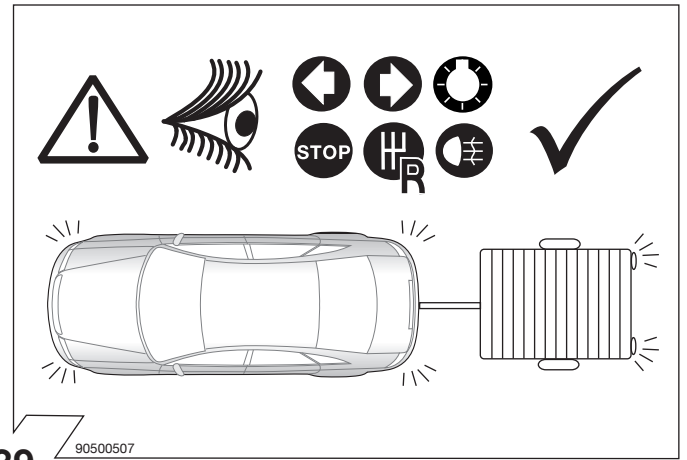

39

90500507

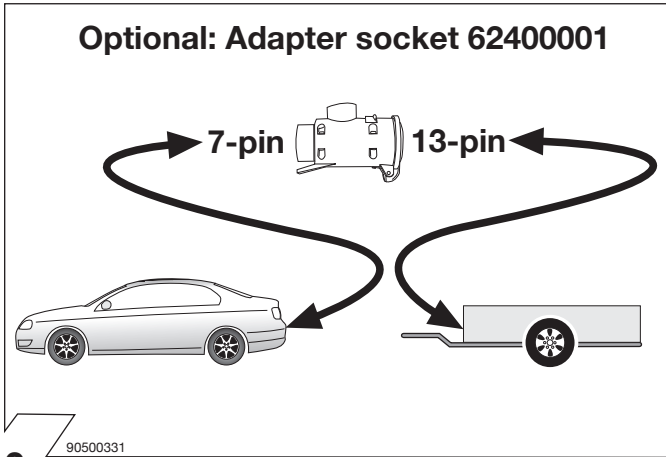

40

90500331

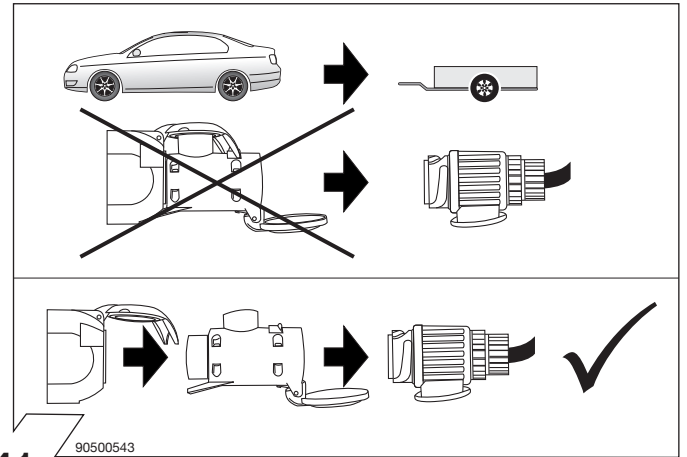

41

90500543



Codierung Steuergerät

Seite 10

Code Control unit

page 10

Codage dispositif de commande

page 10

Codifica dispositivo di controllo

pagina 10



Anhängerbetrieb konfigurieren / Set up trailer operation

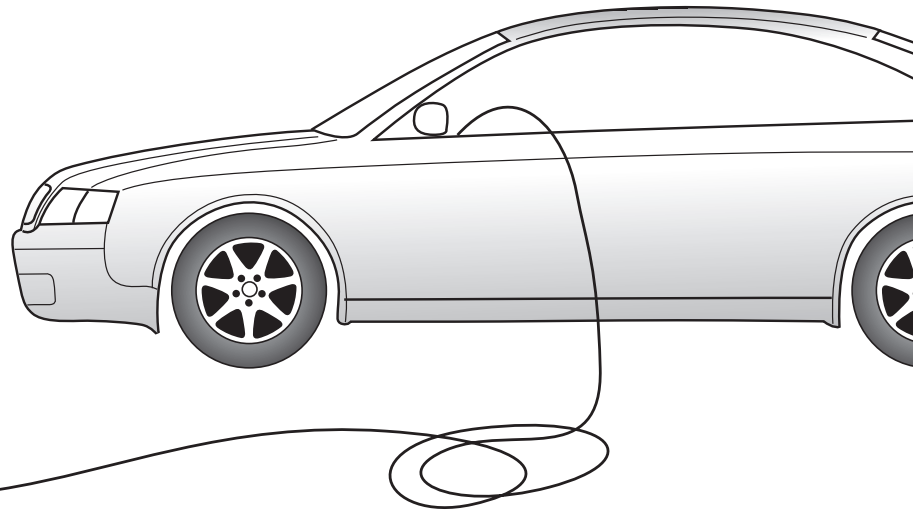
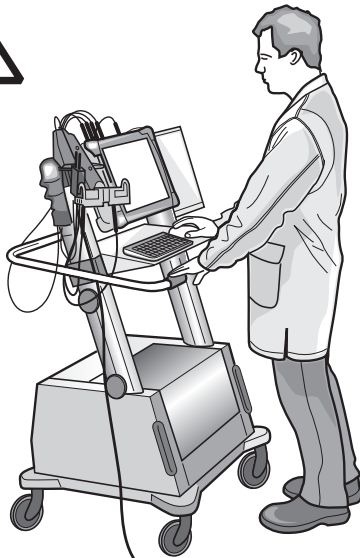

D

Passen Sie die Codierung des Fahrzeuges über geführte Fehlersuche an:

J345 Steuergerät für Anhängererkennung nachrüsten.

Fahrzeuge mit Einparkhilfe

Die automatische Deaktivierung der rückwärtigen Einparkhilfe im Anhängerbetrieb wird durch nachfolgende Codierung des Einparkhilfe-Steuergeräts erreicht:

- Fahrzeug-Eigendiagnose
- 76 – Einparkhilfe
- 07 – Steuergerät codieren
- Den Wert **10000** zur aktuellen Codierung addieren & neu programmieren



GB

Match the vehicle code via selected diagnostics:

J345 retrofit control unit for towing detection.

Vehicles with park assist systems

The automatic deactivation of the rear park assist system in trailer operation will be effected by means of the subsequent coding of the park assist control unit:

- Vehicle self-diagnosis
- 76 – park assist system
- 07 – code control unit
- Add the figure **10000** to the current coding & reprogramme



F

Adaptez le codage du véhicule à l'aide de la recherche guidée des défauts:

J345 équiper véhicule avec calculateur pour reconnaissance de remorque.

Véhicules avec système d'aide au parking

L'aide au parking arrière est désactivée automatiquement dans le mode remorque par le codage suivant du dispositif de commande du système d'aide au parking:

- autodiagnostic du véhicule
- 76 – aide au parking
- 07 – coder le dispositif de commande
- additionner la valeur **10000** au code actuel et effectuer un nouveau paramétrage



I

Adattare la codifica del veicolo mediante ricerca guasti eseguita:

J345 equipaggiare veicolo con dispositivo di controllo per riconoscimento rimorchio.

Veicoli con sensori di parcheggio

La disattivazione automatica dei sensori di parcheggio posteriori quando è attaccato un rimorchio si ottiene attraverso la seguente programmazione della centralina di controllo dei sensori:

- Autodiagnosi del veicolo
- 76 – Sensori di parcheggio
- 07 – Codificare la centralina di controllo
- Aggiungere il valore **10000** al codice attuale e riprogrammare

42

90500700

HINWEIS

Bei Fahrzeugen mit **Bordnetzsteuergerät Lowline** und fehlendem **Fahrerinformationssystem (FIS / Ausstattungsmerkmal 9Q3)** wird ein Blinkerausfall am Anhänger **nicht** über das zentrale Display im Kombi-Instrument angezeigt!

Nach Einbau von Elektrosatz und Anhängermodul 52011506 muß die Kontrollleuchte für Anhängerbetrieb (C2) im Kombi-Instrument mittels **VW/AUDI-Diagnosegerät 5051/52** freigeschaltet werden.

NOTE

In vehicles with a **power supply control unit Lowline** and missing **driver information system (FIS / equipment feature 9Q3)** a flasher failure in the trailer will not be shown in the central display in the combination instrument!

After installation of the electric kit and trailer module 52011506 the control lamp for trailer mode (C2) in the combination instrument must be enabled by means of **VW/AUDI - diagnosis unit 5051/52**.

ATTENTION

Sur les véhicules possédant un **dispositif de commande de circuit de bord Lowline** et auxquels il manque un **système d'information du conducteur (SIC/ désignation de l'équipement 9Q3)**, un dysfonctionnement du clignotant de la remorque ne s'affiche **pas** sur l'écran central de l'instrument combiné.

Après le montage du kit de connexion électrique et du module de remorque 52011506, le voyant de contrôle de l'instrument combiné signalant le fonctionnement avec remorque (C2) doit être activé au moyen de l'**appareil de diagnostic VW/AUDI 5051/52**.

AVVERTENZA

Nei veicoli con **centralina della rete di distribuzione elettrica Lowline** e senza **sistema d'informazione per conducente (FIS / contrassegno dotazione 9Q3)**, l'avaria della freccia del rimorchio **non** viene visualizzata sul display centrale dello strumento combinato!

Dopo il montaggio del set elettrico e del modulo rimorchio 52011506, la spia di controllo per l'esercizio rimorchio (C2) deve essere abilitata nello strumento combinato mediante l'**apparecchio di diagnosi VW/AUDI 5051/52**.

43